

LA-5303-MS

INFORMAL REPORT

CIC-14 REPORT COLLECTION  
**REPRODUCTION  
COPY**

C.3

~~12~~

# An Apparatus for the Reduction of Tritium Emissions into the Atmosphere



**los alamos**  
**scientific laboratory**

of the University of California

LOS ALAMOS, NEW MEXICO 87544



In the interest of prompt distribution, this LAMS report was not edited by the Technical Information staff.

Printed in the United States of America. Available from  
National Technical Information Service  
U. S. Department of Commerce  
5285 Port Royal Road  
Springfield, Virginia 22151  
Price: Printed Copy \$3.00; Microfiche \$0.95

LA-5303-MS  
Informal Report  
UC-41

ISSUED: June 1973



# An Apparatus for the Reduction of Tritium Emissions into the Atmosphere

by

C. M. Dube\*  
D. O. Coffin  
R. D. Stoll

\*Present Address: Rice University, Houston, Texas



AN APPARATUS FOR THE REDUCTION OF TRITIUM  
EMISSIONS INTO THE ATMOSPHERE

by

C. M. Dube

D. O. Coffin

R. D. Stoll

ABSTRACT

A method is described for the removal of tritium from exhaust gases. The equipment and techniques are presented for the conversion of tritium to tritium water using a catalytic converter and the subsequent capture of the tritium water on molecular sieves. The test gas contained 0.5% tritium, and using flow rates between 100 cm<sup>3</sup>/min and 500 cm<sup>3</sup>/min, a reduction occurred in the amount of tritium in the exhaust gas by a factor of over 250,000.

I. INTRODUCTION

An Environmental Control System (henceforth called ECS), is here described which processes "waste" gas evacuated from a primary system and reduces the emission of radioactive tritium into the atmosphere. The "waste" gas is a mixture of air, tritium, deuterium, and helium-3 of varying proportions. The basic chemical process is as follows. The gas is mixed with air and then forced through a catalytic converter which combines the oxygen in the air with the hydrogen isotopes to form water (heavy water and tritium water). The mixture then flows through a molecular sieve which adsorbs the water. The remaining gas is released into the atmosphere.

II. MECHANICAL DESIGN

A schematic of the system is presented in Fig. 1. Gas is pumped into a holding tank from the primary system. Valve V0 is controlled by the primary system. The ECS may be started either when the holding tank pressure reaches a preset value (approximately 15 psig), or by a time switch, or manually. The gas is pumped from the holding tank by a bellows pump through a pressure regulator set at 1 psig

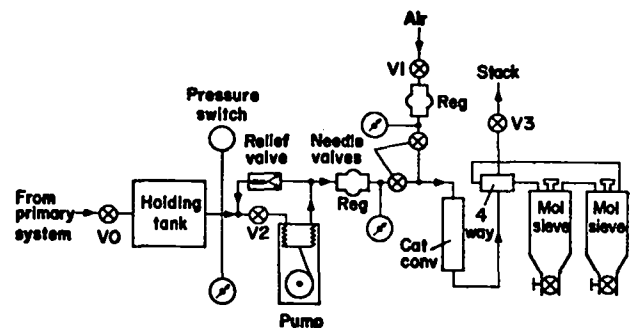

Fig. 1. System schematic.

and a micrometer needle valve. The pump has a maximum allowable output pressure of 25 psig; therefore a relief valve set at 10 psi differential is provided to bleed excess gas back into the holding tank.

Air is injected into the system by an identical pressure regulator and needle valve arrangement as shown in Fig. 1. The two gas streams mix and flow at a low rate through the catalytic converter where the hydrogen isotopes combine with oxygen to form water. The vapor mixture is then directed sequentially by a 4-way valve through two containers filled with molecular sieve material, where the water

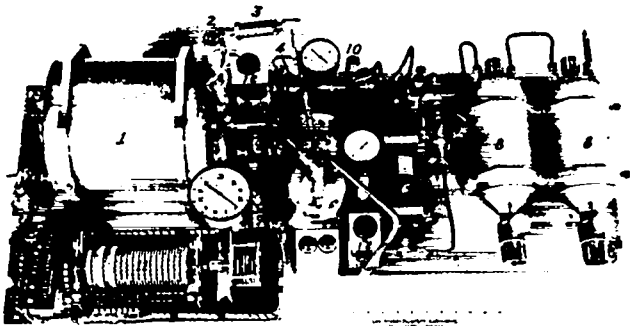

Fig. 2. Environmental Control System.

1. Holding tank
2. Pressure switch
3. Relief valve
4. Air supply
5. Bellows pump
6. Catalytic converter
7. 4-way valve
8. Molecular sieve containers
9. Solenoid valves
10. Needle valves
11. Programmer
12. Pressure regulator

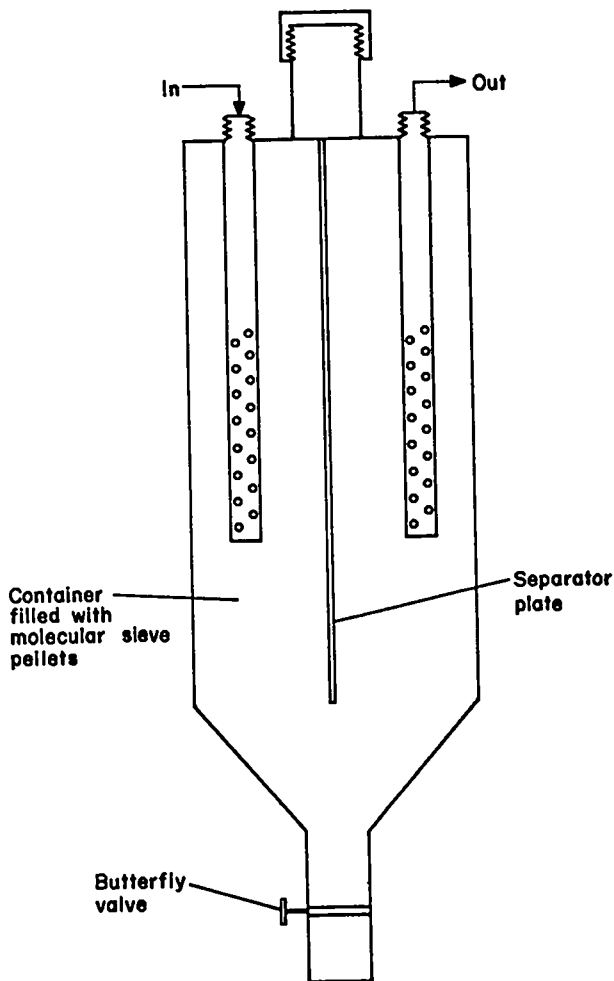

Fig. 3. Molecular sieve container.

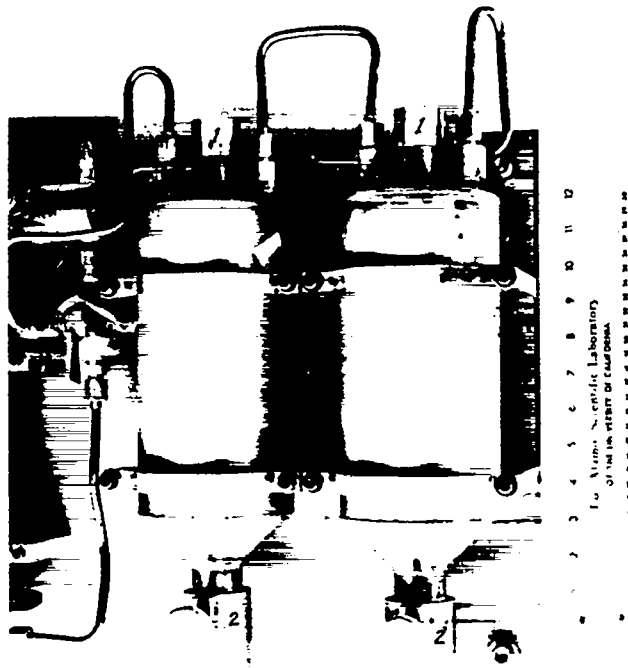

Fig. 4. Molecular sieve containers.

1. Filling cap
2. Butterfly valve

is removed. The remaining dry gas passes back through the 4-way valve and out a stack. Processing stops when the pressure in the holding tank is reduced to a value preset on the pressure switch.

The proposed mounting location made it necessary to make the system as compact as possible. General dimensions are indicated in Fig. 2. The two molecular sieve containers have butterfly valves mounted on funnelled bases so the contaminated sieve pellets (Linde Molecular Sieve - Type 13X) can be drained periodically and replaced. Figures 3 & 4 illustrate the basic sieve container design. Soft copper tubing and flare fittings are used throughout.

### III. CONTROL AND ELECTRICAL SYSTEM

The ECS is controlled by a stepping switch programmer (see Fig. 5). The programmer is basically a drum made up of disks which rotate as a single unit through 24 positions. Pegs which fit on the rim of a disk actuate a lever-operated switch when the disk is rotated to the proper position. The programmer is provided with connections to induce single

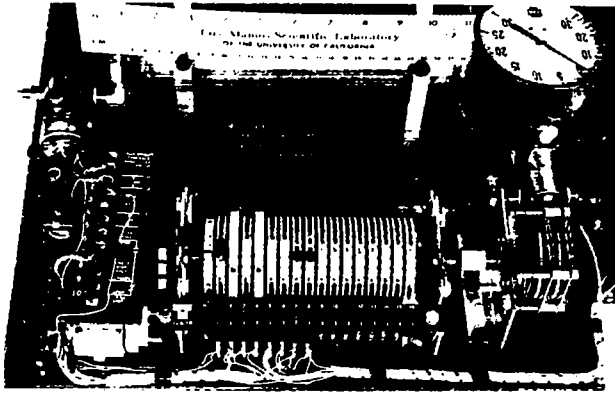

Fig. 5. Stepping switch programmer.

or continuous stepping of the drum. The programmer is programmed for sequential operations by the appropriate placement of pegs and accompanying signal circuitry through the lever switches. The sequence of operations for a time switch initiated cycle is as follows. (Refer to Figs. 6 and 7.) When the time switch closes the programmer advances one step. The solenoid valves V1, V2, and V3 open (see Fig. 1), the pump starts, and the pressure switch circuit is partially completed. The processing of the gas then proceeds. When the holding tank pressure drops to a prescribed value, the pressure switch closes causing the programmer to single step.

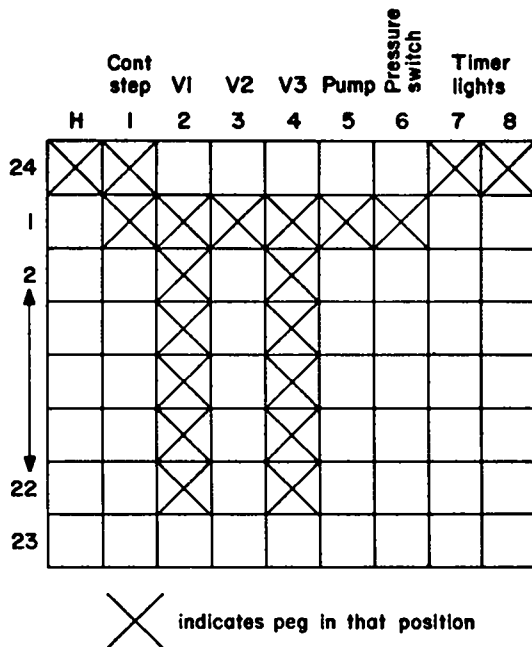

Fig. 6. Drum program chart.

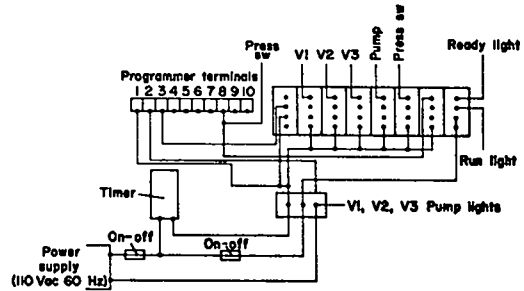

Fig. 7. ECS electrical system schematic.

Valves V1, V2, and V3 close and the pump stops. A circuit through lever switch #1 is completed to the continuous stepping input. The drum rotates until at position 24 the continuous stepping circuit is broken, placing the programmer in the ready position for a new cycle. Signal lights connected through lever switch #8 indicate whether the system is in the "READY" or "RUN" mode.

Because the system is automatically controlled, it can be operated during off hours. However, since operation of the system may be unsupervised and because of the hazardous nature of tritium, an abort feature has been included in case of pump or power failure. Should pump performance drop resulting in insufficient vacuum to operate the pressure switch, a time switch cuts power to the system after a certain period. This causes the pump to stop and all valves to close. The "RUN" light remains on, indicating a malfunction to personnel upon return. The same thing happens in the event of a temporary power failure. A manual ON-OFF switch is also included in the circuitry. All power is drawn from a standard 120 VAC-60 Hz supply.

#### IV. TEST PROGRAM

The output of the ECS was fed directly into a Kanne chamber at known flow conditions to yield a quantitative measure of the extremely low tritium concentration. The Kanne chamber is a very sensitive ionization chamber used to monitor gaseous radioactive  $\beta$ -emitting contaminants. A mass spectrographic analysis of the test gas, before processing, showed its composition to be:

T <sub>2</sub>	0.47%
D <sub>2</sub>	41.65%
H <sub>2</sub>	0.33%
<sup>3</sup> He	0.32%
N <sub>2</sub>	47.33%
O <sub>2</sub>	9.90%

The test procedure was as follows. Gas was pumped into the holding tank from a large reservoir through valve V0. The valve was then closed and the ECS started manually. The gas was pumped from the holding tank at approximately 80 cm<sup>3</sup>/min (STP). The output signal from the Kanne chamber was recorded on a chart recorder. The total amount of T<sub>2</sub> escaping from the ECS may be determined by integrating the amp vs time curves. The calculation is:

$$\text{cm}^3 \text{ of T}_2 \text{ out} = \frac{A \times 2.3 \times 10^7 \frac{\mu\text{Ci}}{\text{cm}^3} \text{-amp} \times F}{2.6 \times 10^6 \frac{\mu\text{Ci}}{\text{cm}^3}}$$

where A = integral under amp vs time curves, amp-min; F = Flow Rate in Kanne Chamber =  $39.6 \times 10^3 \frac{\text{cm}^3}{\text{min}}$ . Numerical values are standard conversion factors. In an 85.5 min test run 6737 cm<sup>3</sup> of gas (31.7 cm<sup>3</sup> of T<sub>2</sub>) was processed. A total of  $10.97 \times 10^{-5}$  cm<sup>3</sup> of T<sub>2</sub> was released into the atmosphere. Thus,

the T<sub>2</sub> content of the gas was reduced by a factor of 288,900.

It was observed that the concentration of T<sub>2</sub> in the ECS exhaust continued to rise throughout the tests. This gradual rise in concentration is assumed to be caused by the adsorption of tritium water onto the molecular sieve and the associated vapor pressure increase. The increase in concentration might be expected to increase over a long period of time to some maximum acceptable level, whereupon the contaminated sieve pellets would be replaced. However, experience with the system should yield more information about the ECS long term operating characteristics.

#### V. SUMMARY

An effective method of reducing tritium emissions into the atmosphere has been demonstrated. Operation of the system is automatically controlled and easily monitored. The molecular sieve containers are designed for easy and safe maintenance. Experience with the long term operating characteristics of the system will probably lead to modifications improving this initial ECS model.

#### APPENDIX

#### MATERIALS

The following materials were used in the construction of the ECS.

Part Number	Number Required	Description			
1	1	Holding tank - 9 liters -316 stainless steelwelded.	8	2	Molecular Sieve Containers - 316 Stainless steelwelded.
2	1	Pressure Switch - "Bristol" Model 506008-05-3.	9	4	Solenoid Valve - "Skinner" #V5D 3870.
3	1	Relief Valve - "Circle Seal" 5159B.	10	2	Micrometer Needle Valve - "Hoke" 2335F4Y.
5	1	Bellows Pump - "Met-Bel" Model MB-150.	11	1	Programmer - "Tenor" 2420.
6	1	Catalytic Converter - "De-Oxo" Model D-50-1000.	12	2	Pressure Regulator "Kendall" Model 30 Cat. No. 30152.
7	1	4-Way Valve - "Circle Seal" P4-418T.			

CM:419(130)